



**Kingfisher  
Lighting**

Part of the LUCECO group of companies

# Trade Product Guide

[www.kingfisherlighting.com](http://www.kingfisherlighting.com)

Issue 5

Introducing CIRECO,  
the dedicated  
circular economy  
luminaire



Your Technical  
Questions Answered by  
the Kingfisher Experts



Part of the **LUCECO**<sub>plc</sub> group of companies



Avondale Square, London

# Contents

11



4 About Us

5 Welcome

17

7 Ask Technical

8 Environmental



42 Luminaire Accessories

23

54 Kingfisher Controls

56 Kingfisher Sport

58 Kingfisher High Mast

29

60 Kingfisher Rail

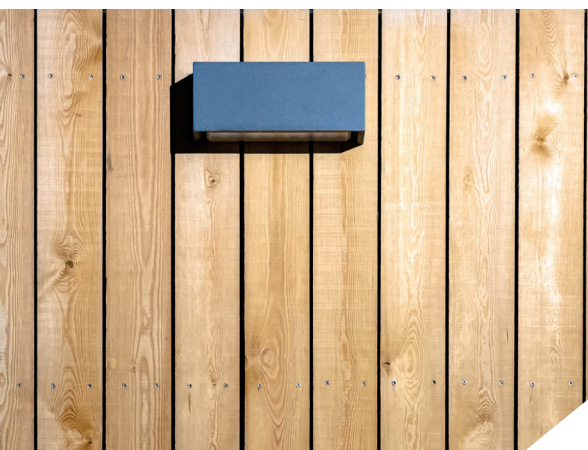

62 LUCECO

64 Other Products Available

37

66 Technical Symbols

67 Glossary

69 Key Contacts

46

70 Index



52

STREET

AMENITY

BOLLARDS

WALL MOUNTED

FLOOD LIGHTS

COLUMNS

ACCESSORIES

# About Us

With over 35 years' experience, Kingfisher Lighting is dedicated to the continual progression of products and services in a bid to create innovative solutions for exterior applications. Ranging from Street and Amenity through to Flood Lights, we have an extensive collection to bring you the best lighting experience.

## Maintenance

Lighting **maintenance experts**, we can help maintain many systems including Kingfisher and Non-Kingfisher schemes. With a specialist focus on sports and high mast schemes, we are able to help fulfil your legal obligations through ensuring your lighting systems are safe and performing to 100%.

## Installation and Commissioning

Do you need lighting checks, flood lights aiming or even an entire installation? Kingfisher have an expert team who work nationwide to ensure you get the greatest results from your site. We work on schemes of all sizes, mostly for sports and high mast applications.

## Project Design Service

Perfect for customers wanting to visualise their installations, we offer a **project design service** with options varying from simple plot calculations to complex 3D visualisations. All lighting schematics include comprehensive layouts detailing fitting types, photometry and lux values which is an excellent opportunity for larger projects.

## Call and Collect Service

Save time and money with our Call and Collect service. With an option for **same day collection**, this service is popular for customers local to Kingfisher HQ or with their own fleet.



Part of the Luceco Group, Kingfisher Lighting join other influential market leaders such as BG Electrical, Luceco LED, Ross, SyncEV, Masterplug and DW Windsor. The Luceco Group's mission is 'to build a leading portfolio of thoughtfully designed and diligently made products that provide environmentally responsible electrical and lighting solutions to our customers.'

## Quick Reference Symbols



### Warranty

We offer a 5-year warranty on all LED luminaires.



### Upgraded

We continually upgrade our products to bring you the best performance at the best price.



### New Product

See the latest products in our range.



### From Stock

We stock hundreds of products which are ready to be delivered to your site anywhere in the country.



### Call & Collect Service

Many of our products are held in stock and ready for you to collect the same day.



# Welcome

Featuring post top luminaires, bulkheads, bollards, columns and much more, this will be your go to guide through the world of exterior lighting. We'll be discussing the latest industry news, giving technical advice and showcasing the latest products within our range.

## In this Issue...

With hot topics such as **circular economy** and the environment on **page 8**, we'll be discussing some of the best practises for these areas and how we're improving our **environmental impact**. This will feature the IDA, circular economy models, single spectrum and so much more.

The Technical Department will address **L and B factors** on **page 7** as well as the importance of installation within sites to achieve the best lighting levels. They'll focus on meeting standards, avoiding obtrusive light and ensuring your replacement scheme best meets the needs of your site.

We'll also be showcasing the latest products and updates to the Kingfisher Lighting including our dedicated circular economy luminaire CIRECO.

## James Miles, Technical Manager says

"At Kingfisher Lighting, we are taking huge steps to minimise our impact on the environment. Our design philosophy is to create high quality luminaires in line with circular economy values, as well as the reduction of packaging. We are proud to have decreased the usage of single-use plastics by up to 96% across our product range."

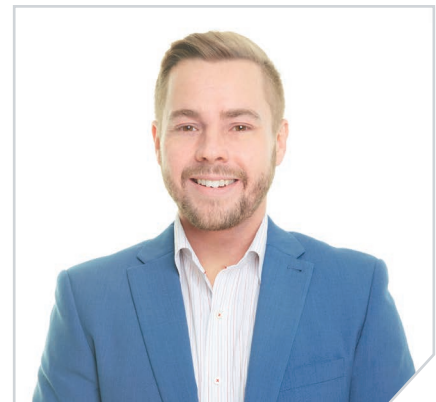

## Accreditations

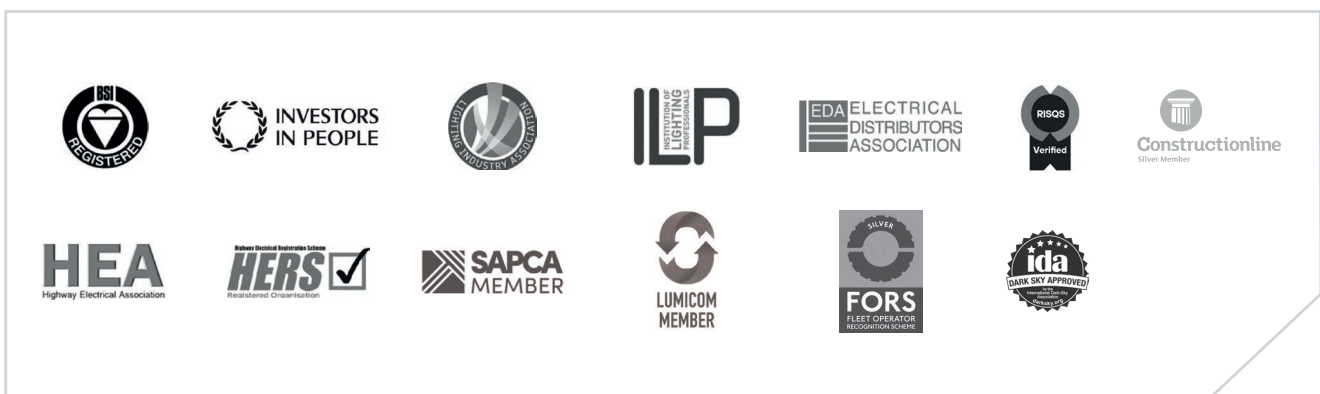

# Accredited CPDs & Product Training

Circular Economy

Questioning Lighting Metrics

Best Practice - Lighting Design

Environmental Impact of Outdoor Lighting on Wildlife

We are accredited through industry leaders, CIBSE and are one of their approved CPD providers.

Our teams are equipped to delivery product training and talks on the industry's hottest topics.

# Ask Technical

With a wealth of industry knowledge, the Kingfisher Technical Team are often asked for their advice on a range of exterior lighting topics. In this issue, we have collated three of our frequently asked questions to help you guide you on the path to better lighting.

## What do L and B Factors mean for LED life?

The lifetime of your luminaire will usually be determined by L, B and even F figures. An example would be 100,000 hours L90, B10.

L = Luminaire Maintenance at rated life

B = Percentage of LED's that would not perform to this maintenance

F = Percentage of LED failures within luminaires.

The usable lifetime between luminaires can differ, despite the majority of products stating 100,000 hours. For example, most manufacturers use L70, B50 indicating the minimum lumen output for that luminaire will be 35% of the original output at the end of its suggested life. We suggest looking for luminaires at L90 B10 as their final output would be around 89%.



## What is your LED Equivalent Product?

When finding an LED alternative, many opt for a like for like approach by matching outputs and efficacies. However, this is not always the best option. Optical distribution within products can often differentiate, this can often result in an incorrect luminaire being chosen in error.

We recommend using a competent lighting designer when planning any scheme upgrade as they will be able to ensure the scheme meets site criteria. They can recommend suitable LED alternatives for sites, provide energy saving calculations and reduce installation costs for projects.

## How Should I Aim a Flood Light?

When it comes to installing your fittings, it is essential to get it right to achieve the necessary levels. Many installers often tilt luminaires to increase the distribution of light however, lighting has developed since HID and by tilting floods sites are at risk of light pollution.

With LED flood lights, there is a preference for flat-to-ground as this adheres to the ILP's GNO1 for the Reduction of Obtrusive Light 2021. When utilising flat-to-ground luminaires, there is no need to tilt allowing less light spill and greater performance throughout spaces.

Kingfisher Lighting can provide a full end-to-end lighting solution from design through to installation and maintenance to provide the best lighting journey possible.



# Environmental

Kingfisher Lighting hold environmental responsibility close to our core. We understand the lighting industry creates a large impact on the environment affecting wildlife, increasing the use of landfill sites and raising carbon emissions. However, we are dedicated to making a difference, starting with our own practices with a target to achieve Net Zero by 2025.

## Circular Economy

We've adopted a circular economy model when manufacturing luminaires. This ensures that from the design stage all the way to the final product, precautions have been taken to ensure all elements of the luminaires can be replaced or recycled, reducing the amount of waste going to landfill.

We're pleased with the introduction of **CIRECO**, the **dedicated circular economy luminaire** equipped with ZHAGA technology providing a future proof solution for street applications. See **page 15** for more details.



## International Dark-Skies Association

80% of the world's population live underneath a light polluted sky and it is time for that to change. Light pollution is caused by anthropogenic activities and can affect the way we live, the way animals live and not forgetting how wildlife live. However, it is one of few pollutants that can be reversed.

The International Dark-Skies Association have made it their mission to reduce the amount of light pollution and to restore the natural beauty of the night sky. **We have been awarded the IDA 'Seal of Approval'** on a number product ranges including - The **AMNIS Series (Page 41)**, The **SEMITA Series (Page 30)** and The **VIVA-CITY Family (Page 13 and 39)**.





## Ecocentricity

All living species react differently to artificial light, some for the better and some for the worse. However, we have a diverse product offering including **dim to warm** opportunities, colour temperature variants and **single spectrum luminaires**. When utilised in the correct applications, these luminaires can dramatically decrease the implications of artificial light.

Studies have shown that with the use of warmer colour temperatures or even monochromatic outputs, humans, animals and plants are better placed to thrive. Using green allows for birds, plants and greenery to flourish, while red and amber supports the circadian rhythms of bats and other animals.



## Packaging

We have **reduced the usage of single-use plastics by up to 96%** across our product range! We instead utilise recyclable materials including responsibly sourced formed cardboard. We also incorporate the use of paper bags for components such as nuts and bolts as an alternative to plastic.

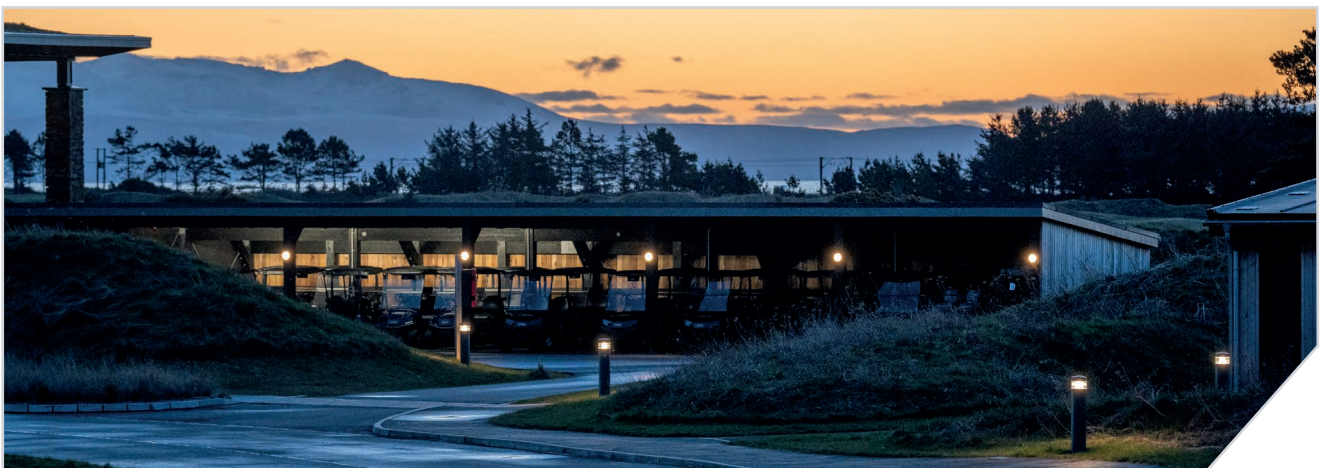

# COSTA D

## We Illuminated 'The Nation's Favourite Coffee Shop'

Costa Coffee was founded by brothers Sergio and Bruno Costa who embarked on their journey in 1971. Since then, they've developed an internationally renowned company with almost 4000 stores spread across 32 countries.

Located on busy roundabouts, industrial parks and near residential areas, glare and back spill need to be minimised for all sites. We create classic and sophisticated schemes for the drive-throughs, building perimeters and car parks.

### The Scheme

We combine a series of street luminaires, bollards and downlighters to create a scheme perfect for the site, meeting all relevant lux levels and BREEAM requirements. The car parks all meet a lux level of 25 throughout with the drive-throughs achieving 50 lux.

When it comes to design, Costa have strict specifications to ensure their classic aesthetic is maintained across every store. Therefore, meeting requirements was particularly tricky however, with our expert design team on hand the client had nothing to worry about.

VIVA-CITY Pro



Our Drive Thru  
is  
**OPEN**  
Thank you and stay safe  
**COSTA**  
COFFEE

DECO 2.0

# Street Lighting



12 AURIGA 2.0



13 VIVA-CITY Pro



14 I-TRON



15 CIRECO

# AURIGA 2.0

AURIGA 2.0 Post Top is the contemporary luminaire bringing high performance functionality for roadways and pedestrian locations.



Scan for Datasheet



## Key Features

- 20W - 120.0W
- 2,732 - 16,920 Luminaire Lumens
- Efficacy up to 149.0 lm/W
- 2700K, 4000K, CRI >70
- Lifetime >100,000hr, L80
- IP66, IK08
- Comfort Option
- Photocell Options
- Emergency Options

## Optics

Asymmetric Street Optic - Area

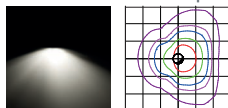

Symmetrical 90° Optic

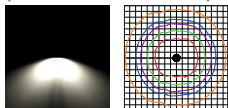

Street Optic - Wide

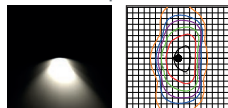

## Dimensions

Body Size	A	B	C	D
Post Top	733	530	158	60/76

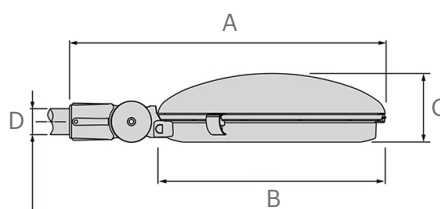

All Dimensions in mm





# VIVA-CITY Pro

The VIVA-CITY Pro is a slimline street lantern with improved efficacy and output that incorporates asymmetrical optics including an area optic.



## Key Features

- 10.0W - 180.0W
- 662 - 24,840 Luminaire Lumens
- Efficacy up to 150.0 lm/W
- 2700K, 4000K, CRI >70
- Lifetime >100,000hr, L80
- IP66, IK08
- Adjustable Output Options
- Dim to Warm Option
- IDA Approved



<b>5 YEARS WARRANTY</b>		<b>100,000 hrs LIFETIME</b>		<b>Control Compatible</b>			

## Optics

FW70	FWB70	AY70
Forward Throw Optic 70°	Spill Shield Forward Throw Optic 70°	Street Optic 70°

## Dimensions

Body Size	A	B	C	D
10W, 20W	525	250	102	60/76
40W, 60W, 80W	625	288	102	60/76
120W, 180W	775	320	102	60/76

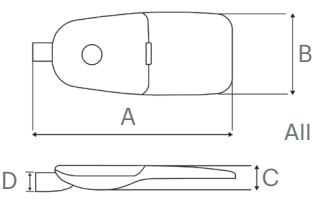

All Dimensions in mm



Scan for Datasheet



# I-TRON

I-TRON is a high-performance street light. The modular lens and reflector based system with high-transparency tempered glass offers energy efficient, quality output.

5  
Years  
WarrantyUpgraded  
+

Scan for Datasheet



## Key Features

- 11.9W - 100.0W
- 1,680 - 14,460 Luminaire Lumens
- Efficacy up to 156.0 lm/W
- 4000K, CRI >70
- Lifetime >100,000hr, L94
- IP66, IK09
- Emergency Options
- Paint Finish Options
- Marine + Finish

## Optics

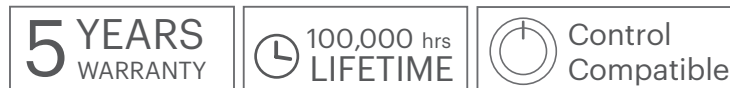
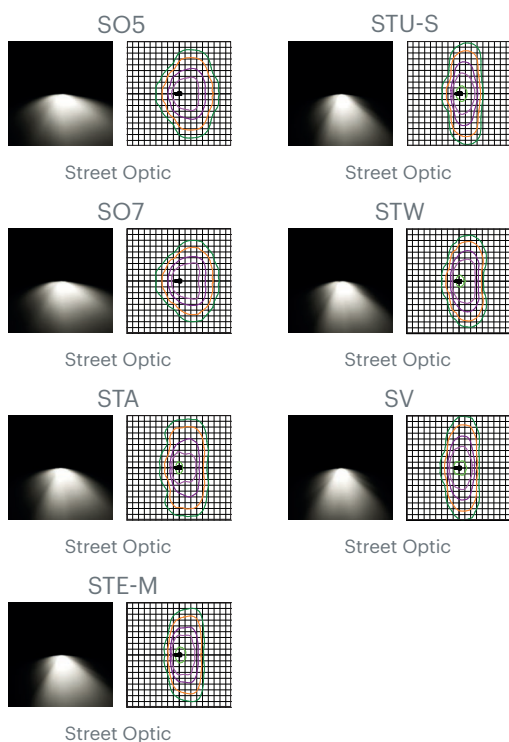

## Dimensions

Body Size	A	B	C	D
Standard	535	345	93	60-76

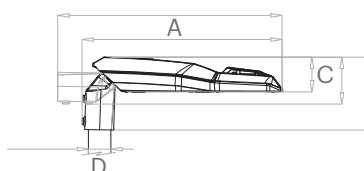

All Dimensions in mm

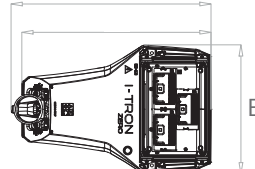

New Product ★ 5 Years Warranty From Stock Call & Collect

# CIRECO

The dedicated circular economy luminaire, CIRECO is the street light designed to the ethos of 'reduce, reuse, recycle'. Featuring innovative LED technology, this fitting features Zhaga components to ensure your site is future proofed.

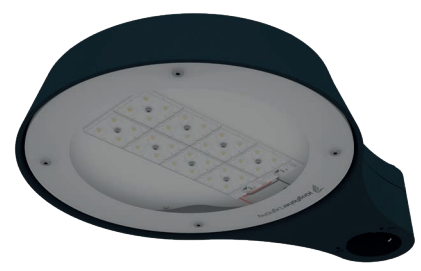

## Key Features

- 25.0W - 75.0W
- 3,561 - 10,925 Luminaire Lumens
- Efficacy up to 152.0 lm/W
- 2700K, 4000K, CRI >70
- Lifetime >100,000hr, L80
- IP66, IK08
- Comfort Option
- Controls Options
- Photocell Options

PEC IK08 IP66 Colour Temperature Marine Grade Finish DALI

5 YEARS WARRANTY 100,000 hrs LIFETIME Control Compatible

## Optics

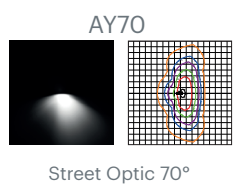

## Dimensions

Body Size	A	B	C	D
Standard	521	360	95	60

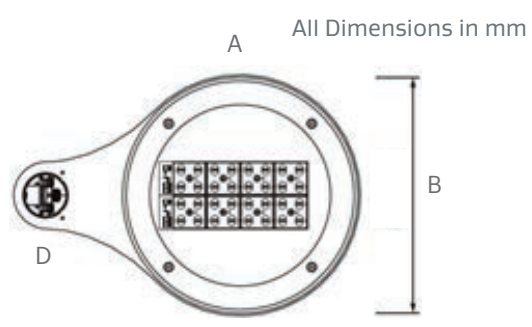

Scan for Datasheet

AURIGA 2.0

# Dundonald Links

A luxury accommodation combining work and play, Dundonald Links is the perfect location for any modern golfer. Located near the coast, the site required a modern lighting scheme to compliment the elegant accommodation whilst also protecting luminaires from high levels of salt spray and wind. Additionally, we illuminated the pathways and roadways to prioritise safety.

After the initial consultation, we opted for a sophisticated scheme utilising warm colour temperatures to match the aesthetic and boost human-centricity. The protection of the luminaires and column were important to retain a high-quality finish, therefore we provided them with a marine grade coating.

## The Solution

Ensuring roads and pathway remain safe after dusk was a key focus for Dundonald Links so, we placed 11 x stirrup mounted and 6 x post top AURIGA 2.0 luminaires situated on 5m columns with marine grade RAL 7024 finish. The modular system promoted a safe, low glare illumination for a comfortable environment.

Creating harmony across the architecture and lighting scheme, we placed KLOU 180 around the lodges. Boasting high quality, the Italian made bollards feature a sleek design and produce a low glare output in 3000K to promote the greatest distribution possible.



# Amenity Lighting



18 VILLA II



19 SLOANE 2.0



20 AURIGA 2.0



21 CIVICA 2.0



Scan for Datasheet

# VILLA II

The perfect lantern to add a heritage look to any scheme. VILLA II is available in LED as well as a range of colour temperatures to suit your applications.



## Key Features

- 30.0 - 60.0W
- 3,450 - 7,270 Luminaire Lumens
- Efficacy up to 130.0 lm/W
- 2700, 4000K, CRI >70
- Lifetime >100,000hr, L80
- IP66, IK08
- Comfort Option
- Dim to Warm Option
- Colour Temperature Options

## Optics

Symmetrical 127° Optic

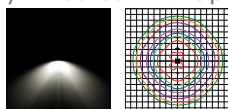

PEC	IK08	IP66	DIM	EM	Colour Temperature	Marine Grade Finish	Control Compatible
DALI	5 YEARS WARRANTY		100,000 hrs LIFETIME		Control Compatible		

## Dimensions

Body Size	A	B	C	D
Standard	816	425	425	60/76

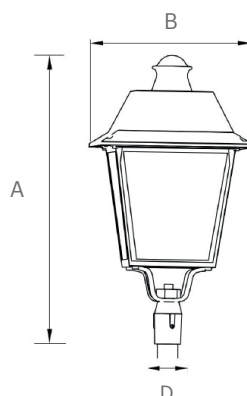
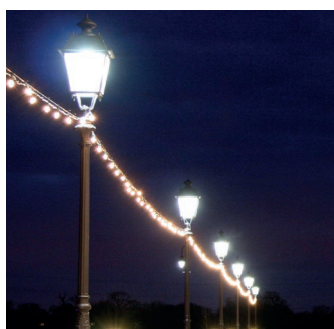

All Dimensions in mm





# SLOANE 2.0

A spherical luminaire with an effective light distribution, SLOANE 2.0 is ideal for large area amenity applications



## Key Features

- 35.0 - 55.0W
- 2,548 - 4,005 Luminaire Lumens
- Efficacy up to 73.0 lm/W
- 4000K, CRI >70
- Lifetime >100,000hr, L90
- IP65, IK10



## Optics

Symmetrical Distribution Optic

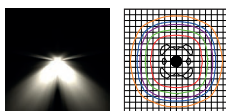

## Dimensions

Body Size	A	B	C	D
Standard	500	0	520	76

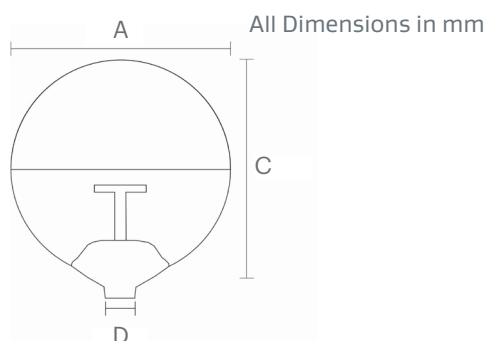

Scan for Datasheet



Scan for Datasheet

# AURIGA 2.0

Featuring an elegant aesthetic, the AURIGA 2.0 Stirrup is a versatile solution with emergency, photocell, comfort and dim to warm capabilities to suit any modern site.



## Key Features

- 20.0W - 60.0W
- 2,732 - 7,950 Luminaire Lumens
- Efficacy up to 149.0 lm/W
- 2700, 4000K, CRI >70
- Lifetime >100,000hr, L80
- IP66, IK08
- Comfort Option
- Photocell Options
- Emergency Options

## Optics

Asymmetric Street Optic - Area

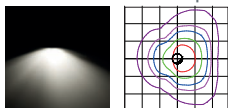

Symmetrical 90° Optic

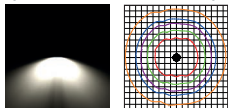

Street Optic - Wide

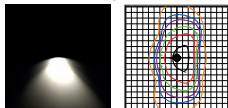

## Dimensions

Body Size	A	B	C	D
Stirrup	733	530	158	60/76

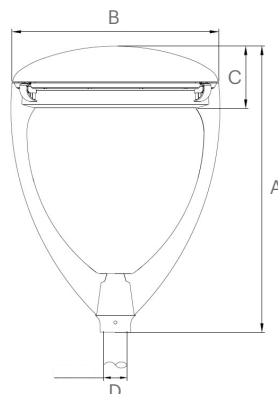

All Dimensions in mm





# CIVICA 2.0

With a classic amenity shape, the CIVICA 2.0 is the robust luminaire that boasts comfort throughout many public realm applications, due to its prismatic diffuser and marine grade finish.



## Key Features

- 40.0W - 60.0W
- 4,048 - 6,700 Luminaire Lumens
- Efficacy up to 112.0 lm/W
- 2700, 4000K, CRI >70
- Lifetime >100,000hr, L80
- IP65, IK08
- Colour Temperature Options
- Photocell Options



## Optics

Symmetrical 90° Optic

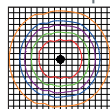
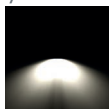

## Dimensions

Body Size	A	B	C	D
Standard	600	600	426	60/76

All Dimensions in mm

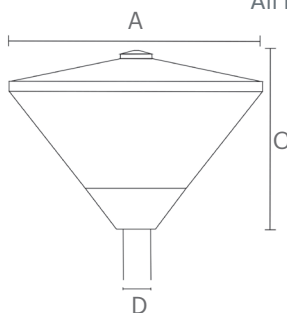

Scan for Datasheet

# Gilwell Park

World-famous 'Home of the Scouts', Gilwell Park has received investment from the Scout Association to develop and upgrade the lighting system to LED.

The estate holds over 100 acres of land and continues to grow with each passing year. A place for scouts and leaders to meet, train, camp and explore, the park is set in a peaceful woodland location and therefore required a minimal obtrusion lighting scheme.

The Kingfisher Project Team carefully selected fittings from our amenity range to enhance the serene aesthetic of the site. However it was of equal importance to achieve the desired lighting levels and functionality needed.

The ECORAYS was chosen due to it's innovative reflector technology base and aesthetic. With a flat glass screen and reflector optics, the luminaire achieves a low glare distribution ensuring its suitability for pedestrian areas and car parks on site.

DECO 2.0 was selected for their classic aesthetic, which lined the driveway and roads without disrupting the overhead tree canopies.



DECO 2.0

# Bollards



25 VAILO



26 HELVELLYN 2.0



27 DECO 2.0









# VAILO

VAILO is a sleek, low glare bollard offering a best-in-class optical system. Available with an array of lumen packages, as well as single or twin sided illumination and adjustable distribution on site.



## Key Features

- 4.0W - 25.0W
- 239 - 2,282 Luminaire Lumens
- Efficacy up to 83/91 lm/W
- 2700, 4000K, CRI >70
- Lifetime >100,000hr, L70
- IP66, IK10
- Fuse Cut Out Options
- Damage Free Opening Tool
- Controls Compatible



## Optics

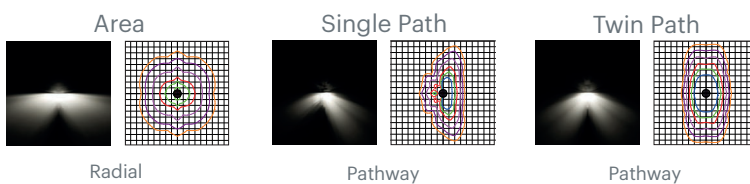

## Dimensions

Body Size	A	B	C
Standard	190	109	1004

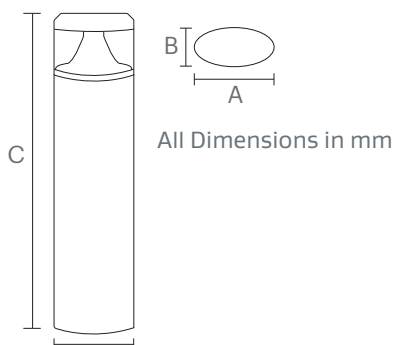

Scan for Datasheet

# HELVELLYN 2.0



Scan for Datasheet

The HELVELLYN 2.0 is a sleek, stainless steel bollard with an onsite adjustable output to optimise performance across sites. Available with photocell and emergency opportunities, HELVELLYN 2.0 is perfect for public realm locations.

BOLLARDS



## Key Features

- 7.5W - 15.0W
- 730 - 1,860 Luminaire Lumens
- Efficacy up to 124.0 lm/W
- 2700, 3000, 4000K, CRI >70
- Lifetime >50,000hr, L70
- IP65, IK08
- Emergency
- 180° Spill Shield
- Impact Kit



## Optics

Radial

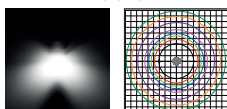

## Dimensions

Body Size	A	B	C
Standard	180	0	1040

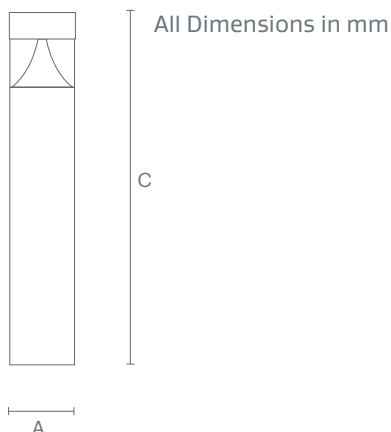



# DECO 2.0

A classic bollard with high versatility levels, the DECO 2.0 has an onsite adjustable output as well as photocell and emergency options to maximise site potential.



## Key Features

- 7.5W - 15.0W
- 930 - 1,860 Luminaire Lumens
- Efficacy up to 124.0 lm/W
- 4000K, CRI >80
- Lifetime >50,000hr, L70
- IP65, IK08
- Emergency
- 180° Spill Shield
- Impact Kit



## Optics

Radial

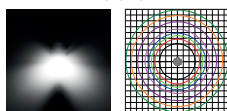

## Dimensions

Body Size	A	B	C
Standard	180	0	1040

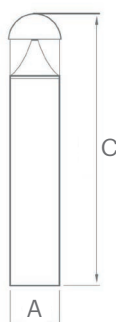

All Dimensions in mm



Scan for Datasheet

A dark blue, rectangular wall-mounted lighting fixture is shown against a background of vertical wooden planks. A long shadow is cast to the right of the fixture. An orange line points from the fixture to a label.

SEMITA Urban

# Broadford Hospital

We illuminated the award-winning Broadford Hospital in the Isle of Skye as part of a £40 million development project.

The scheme required emergency lighting to increase security and improve visibility in the event of an emergency. They also needed a marine grade finish to ensure protection against the harsh environment.

We combined standard and 3hr emergency post top and wall mounted luminaires and included 6m conical columns around the site to create an energy efficient and uniform solution.

The ITALO Series - High quality Italian luminaire with a marine grade finish as standard, the ITALO luminaires were the perfect solution to illuminate the site. We utilised SO5 and STE-M optics around the turning circle and the remaining roadways, car parks and energy centre to get accurate uniformity.

SEMITA Urban - Designed and engineered in the UK, the SEMITA Urban fixture is part of our wall mounted range. It was perfect for lighting building entrances and exits around the community hospital.

Columns - Placed around the site's perimeter, we used our 6 metre conical columns in a marine grade finish in RAL 7024. They ensured luminaires were mounted at the perfect height, reducing the chances of light spill onto the surrounding areas.

# Wall Mounted

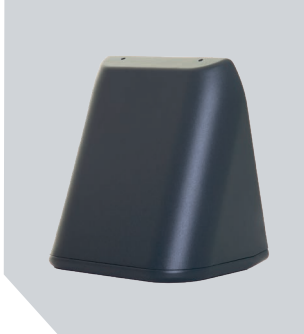

30 SEMITA Arc



34 ATLAS



31 SEMITA Urban



35 FORTIS



32 ALFRESCO Urban



33 QUARTO 2.0



# SEMITA Arc

Bring style and functionality to your schemes with SEMITA Arc.



Scan for Datasheet



## Key Features

- 7.5W - 13.2W
- 649 - 1,615 Luminaire Lumens
- Efficacy up to 122.0 lm/W
- 2700, 4000K, CRI >70
- Lifetime >100,000hr, L80
- IP66, IK09
- Colour Temperature Option
- Emergency Option
- IDA



## Optics

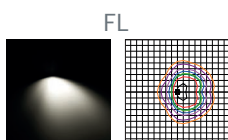

Flood Optic

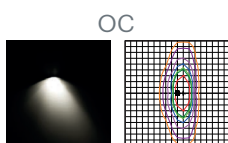

Path Optic

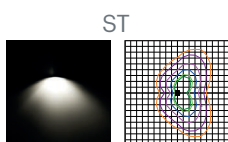

Street Optic



## Dimensions

Body Size	A	B	C
Standard	240	230	158

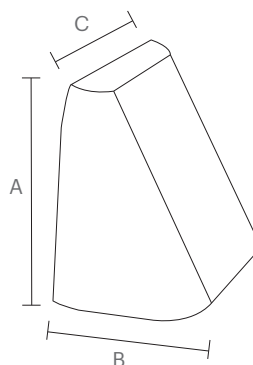

All Dimensions in mm





# SEMITA Urban

Designed and engineered in the UK, SEMITA Urban brings you the perfect balance of form and function

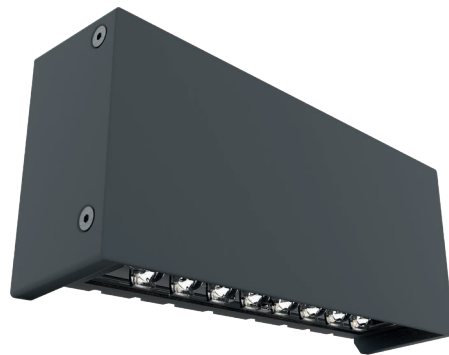

## Key Features

- 6.0W - 11.0W
- 744 - 1,611 Luminaire Lumens
- Efficacy up to 146.0 lm/W
- 2700, 4000K, CRI >70
- Lifetime >100,000hr, L80
- IP66, IK10
- IDA
- Comfort Option
- Emergency Options



## Optics

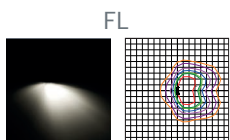

Flood Optic

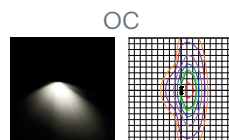

Path Optic

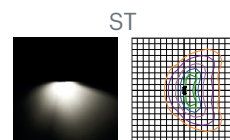

Street Optic

## Dimensions

Body Size	A	B	C
Standard	337	148	82

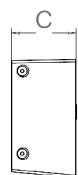
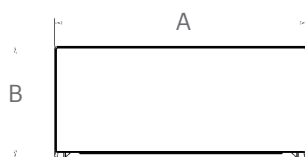

All Dimensions in mm



Scan for Datasheet

WALL MOUNTED

# ALFRESCO Urban

Featuring a classic wall mount design, ALFRESCO Urban was developed from high quality die-cast aluminium to provide a durable finish for many applications



Scan for Datasheet



## Key Features

- 20.0W
- 1,813 - 2,147 Luminaire Lumens
- Efficacy up to 107.0 lm/W
- 2700, 4000K, CRI >80
- Lifetime >50,000hr, L70
- IP65, IK08
- Emergency Options
- Photocell Options
- Motion Sensor Option



## Optics

Asymmetrical 180 X 90° Optic

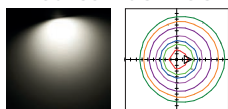

## Dimensions

Body Size	A	B	C
Standard	340	340	105

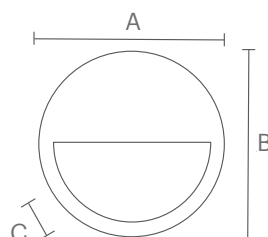

All Dimensions in mm







# QUARTO 2.0

A stylish, modern bulkhead available with LED emergency and photocell. QUARTO 2.0 is suited to building and perimeter lighting.



## Key Features

- 7.5W - 14.2W
- 720 - 1,720 Luminaire Lumens
- Efficacy up to 121.0 lm/W
- 2700, 4000K, CRI >70
- Lifetime >100,000hr, L80
- IP66, IK10
- Motion Sensor
- Emergency
- Colour Temperature Options



**5 YEARS**  
WARRANTY

**100,000 hrs**  
LIFETIME

## Optics

FL

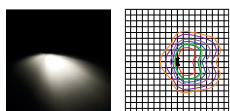

Flood Optic

OC

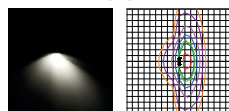

Path Optic

ST

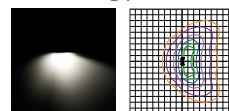

Street Optic

## Dimensions

Body Size	A	B	C
Standard	231	230	230



All Dimensions in mm

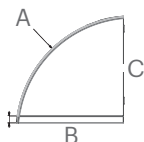

Scan for Datasheet

# ATLAS

Suitable for exterior and interior placements, the ATLAS provides a low impact distribution through the opal diffuser as standard.



Scan for Datasheet



## Key Features

- 21.0W
- 2,100 Luminaire Lumens
- Efficacy up to 100.0 lm/W
- 4000K, CRI >80
- Lifetime >50,000hr, L70
- IP65, IK08
- Colour Temperature Option
- Emergency Option
- IDA

## Optics

Asymmetrical Distribution

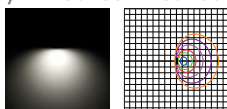

## Dimensions

Body Size	A	B	C
Standard	317	317	103

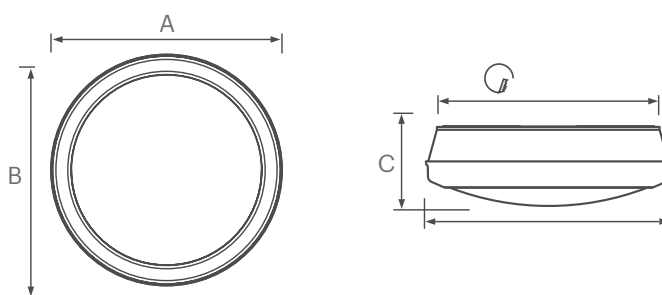
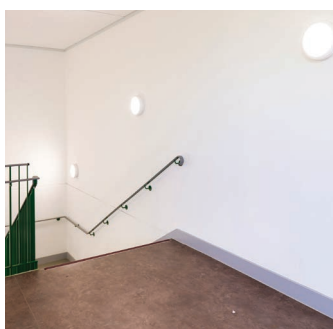

All Dimensions in mm



# FORTIS

FORTIS is a versatile bulkhead perfect for illuminating building perimeters. Available with photocell, digital dimmable and emergency options, it is the ideal replacement for HID bulkheads.



## Key Features

- 15.0W - 35.0W
- 1,500 - 3,500 Luminaire Lumens
- Efficacy up to 100.0 lm/W
- 4000K, CRI >80
- Lifetime >50,000hr, L70
- IP65, IK08



## Optics

Asymmetrical Distribution

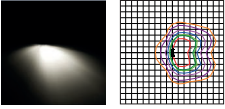

## Dimensions

Body Size	A	B	C
Standard	336	336	212

All Dimensions in mm

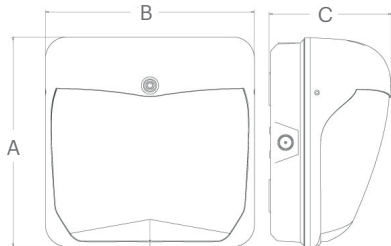

Scan for Datasheet

WALL MOUNTED

# Mildenhall Hub

After £39 million of investment, Mildenhall Hub is part of the governments 'One Public Estate Programme'. A focal point in the community providing public services, education and recreational activities, the centre required a modern lighting scheme for the public area after dusk.

Located in close proximity to residential areas, the site needed to keep light obtrusion to a minimum, increase safety measures and enhance visual comfort. Therefore, the Kingfisher Lighting team utilised a combination of luminaires and columns to create excellent uniformity and optimised site functionality.

ZACTIS was placed in the car parks, bus pick up and drop off areas. It's 0% ULOR allows minimal light pollution to come from the luminaire. Placed on 8m columns, the luminaire created a powerful projection ensuring a clear visual for extra security.

Both post top and stirrup mounted AURIGA 2.0's lined the pathways and common areas ensuring clarity for all areas. The luminaires were fitted with 3 hour emergency which ensures a safe passage to muster points during a power outage.

Placed along building perimeters, QUARTO 2.0 was the perfect choice with a dedicated pathway optic providing the exact amount of illumination needed for the site. The flat-to-ground fitting allows a reduction in ULOR alike ZACTIS ensuring minimised pollution.

DECO 2.0 is the classic bollard placed in several areas of the site to help reduce the amount of overhead lighting were unnecessary. The bollard provided a subtle and comfortable illumination through the reflector based cone.

Overall, the site achieved great uniformity whilst minimising the light pollution and reducing costs throughout. With added emergency the site is future proofed in the case of an emergency ensuring all visitors and staff are able to navigate their way to muster points.



ZACTIS

# Flood Lighting



38 GUARDIAN Pro



39 VIVA-CITY Flood

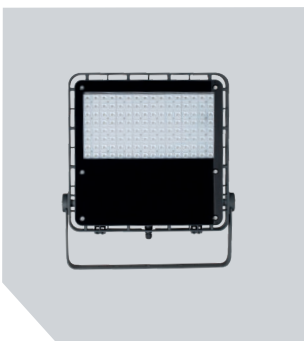

40 ZACTIS



41 AMNIS Series

# GUARDIAN Pro

GUARDIAN Pro is the asymmetric flood light hosting a powerful distribution in a compact package. With an adjustable bracket, the luminaire can be angled to get the perfect illumination for your scheme.



Scan for Datasheet



## Key Features

- 50.0W - 150.0W
- 6,800 - 19,200 Luminaire Lumens
- Efficacy up to 136.0 lm/W
- 4000K, CRI >70
- Lifetime >70,000hr, L80
- IP65, IK08

## Optics

Asymmetric Flood Optic

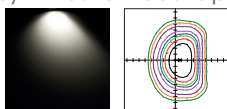

**5 YEARS**  
WARRANTY

## Dimensions

Body Size	A	B	C
50W	335	252	148
100W, 150W	415	296	127
200W	467	320	147

All Dimensions in mm

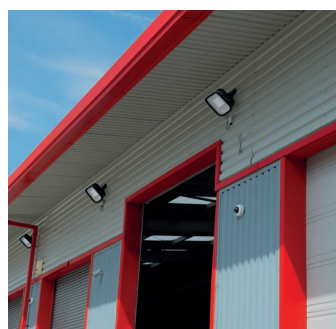
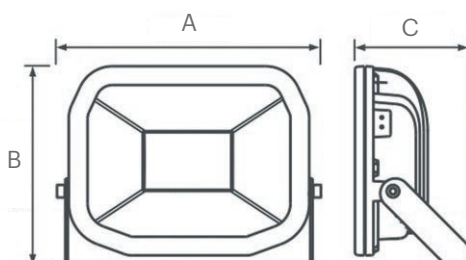



# VIVA-CITY Flood

Part of the VIVA-CITY family, the VIVA-CITY Flood is a sleek, powerful luminaire with asymmetrical distribution.



## Key Features

- 60.0W - 120.0W
- 6,440 - 16,780 Luminaire Lumens
- Efficacy up to 140.0 lm/W
- 2700, 4000K, CRI >70
- Lifetime >100,000hr, L80
- IP66, IK09
- IDA
- Colour Temperature Option
- Photocell Options



**5 YEARS**  
WARRANTY

**100,000 hrs**  
LIFETIME

## Optics

FW70

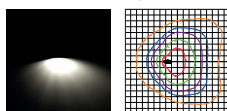

Forward Throw Optic 70°

FL50

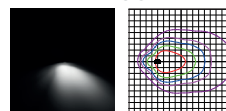

Flood Optic 50°

## Dimensions

Body Size	A	B	C
Standard	488	386	81

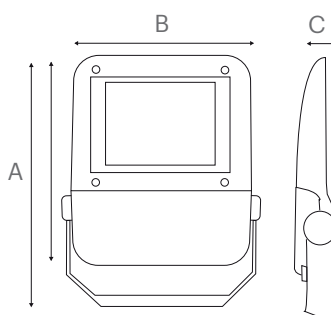

All Dimensions in mm



Scan for Datasheet

# ZACTIS

ZACTIS is a high-performance flat-to-ground LED flood light perfect for sports, high mast and area applications. As well as facilitating easy installation and maintenance, the sleek, low profile design, reduces the load together with decreasing windage.



Scan for Datasheet



## Key Features

- 125.0W - 320.0W
- 16,447 - 44,156 Luminaire Lumens
- Efficacy up to 138.0 lm/W
- 2700, 4000K, CRI >70
- Lifetime >100,000hr, L70
- IP65, IK08



## Optics

FW70

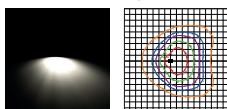

Forward Throw Optic 70°



## Dimensions

Body Size	A	B	C
Standard	610	540	65

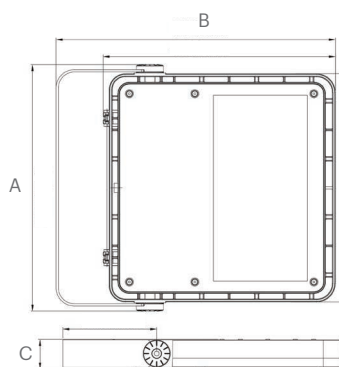

All Dimensions in mm

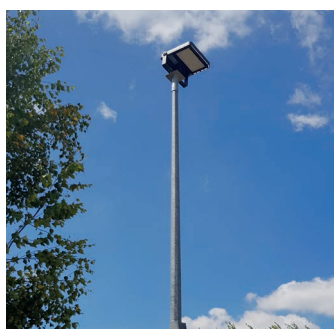



10 Years Warranty

From Stock

Call & Collect

# AMNIS Series

A powerful, high-performance luminaire designed and engineered in the UK offering a pitch perfect output and outstanding efficiency.



## Key Features

- 450.0W - 1350.0W
- 59,000 - 188,662 Luminaire Lumens
- Efficacy up to 145.0 lm/W
- 2700, 4000K, CRI >70
- Lifetime >100,000hr, L70
- IP66, IK08
- Flicker Free, HDTV Ready
- Tier 1 Integral or Separate Driver Options
- IP68 Potted Driver Housing with Independent Surge Protection



## Optics

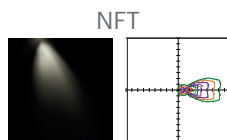

Narrow Far Throw

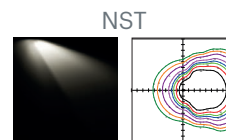

Narrow Short Throw

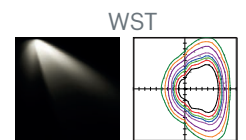

Wide Short Throw

## Dimensions

Body Size	A	B	C
Match	461	808	278
Flood	700	840	153

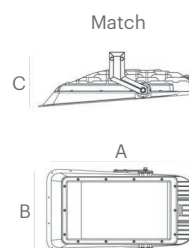
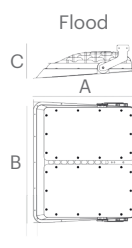

All Dimensions in mm



Scan for Datasheet

# Luminaire Accessories



## Emergency

Varying from standard 3 hour through to DALI and DALI self-test emergency, we host a collection of luminaires available with this function to help enhance safety across many projects.



## Photocell

This light sensor allows light to only appear after dusk saving energy and allowing light to appear only when it is needed.



## Motion Sensor

Prompted by movement, this solution is best utilised with our wall mounted luminaires. With varying detection areas and holding times available, luminaires can be customised to meet exact needs.



## PIR

Similar to motion sensors, PIR (Passive Infra Red) detectors also work when they sense movement. They operate through the detection of heat signatures so they cannot be triggered by inanimate objects.



## Dim to Warm

This system allows luminaires to operate between 2700K and 4000K through Kingfisher Controls. Increasing versatility, this innovative system is perfect for dark-sky and conservation areas.

## Comfort Options

From low colour temperatures, diffuser options and bespoke optical packages, we have many solutions throughout the Kingfisher range to enhance comfort across sites.

## Paint Options

We can offer many paint finishes and RAL options with several of our luminaires to help create a harmonious aesthetic for sites.

## Single Spectrum

Single spectrum is the use of monochromatic light outputs within lighting instead of the typical white illumination. The system can be utilised in a variety of locations including conservation and wildlife areas.

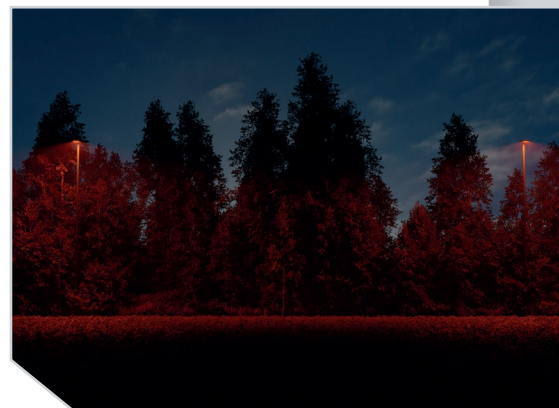



AMNIS Series

# Montrose FC

Founded in November 1879, Montrose Football Club helps bring together the local Montrose community through the love of football. Based at the Links Park Stadium since 1887, the club have recently achieved Silver Quality in alignment with the Scottish FA requirements, with the help of Kingfisher Sport.

The club required an upgrade to their previous lamped technology which achieved 350 lux. With an aim to save costs as well as achieve Silver Standard, they desperately needed to make the move to LED.

With many surrounding properties, the site also needed to adhere to the ILP 2021 Guidance Notes on Obtrusive Lighting (GN01). Therefore, the best solution was a flat-to-ground flood light with 0% ULOR.

The AMNIS Series was the perfect solution for the site due to its innovative reflector technology system. 32 fixtures were placed around the pitch on pre-existing masts and required bespoke bracketry to mount the luminaires, saving the club money on hardware and installation costs.

The high-performance flood allows an excellent light projection which achieves 500 lux, perfectly suiting the Scottish FA's Silver Standard.

The AMNIS Series comes in a marine grade finish as standard therefore if extreme weather conditions were to occur, it's protective coating would ensure the luminaires remain in excellent condition for the duration of the 100,000 hour recommended lifetime.

Overall, Montrose Football Club received a state-of-the-art lighting system to help them progress further and achieve silver standard. The surrounding properties also remain undisturbed due to the advanced technology system of the AMNIS.

## Columns, Brackets and Accessories



46 Columns



50 Amenity and Highway



51 Flood Light



52 Accessories



# Columns

Column experts for over 30 years, we have a vast collection of columns to suit all projects from street to car parks to residential areas and even high mast facilities.

## Expert Advice

Drawing from many years of experience, the Kingfisher team will be able to match columns with luminaires and brackets to ensure you get the best results. The in-house lighting design team will be able to assist with specifications ensuring lux levels and uniformity are achieved.

## Nationwide Delivery

To enable safe and fast offloading, we have specialist hi-ab equipment on our fleet to reduce the need of additional site equipment ensuring the smoothest transition possible. We also offer free delivery on orders over £500 in mainland GB (exclusions apply to certain parts of the Southwest and Scotland).

## Maintained Stock Levels

We have an extensive stock of columns held at our warehouse alongside an in-house fabrication facility. In addition, we can provide a variety of finishes and RAL colour for columns to ensure the perfect aesthetic for many projects.

## Hinged Options

For easy access in limited space, the base and mid hinged columns are ideal for ground level maintenance without the need to hire lifting equipment. Hinged at either the base or the middle of the columns, the column can be lowered via a winch or pulley tool.



# Columns Shape

## Tubular Steel (3m – 12m)

We host a comprehensive selection of tubular lighting columns suitable for residential, street and amenity locations.

- Flange plate or root mount
- Outside fitting door
- Available in standard or base hinged options
- Manufactured from steel tube with tapered joint between the base and shaft

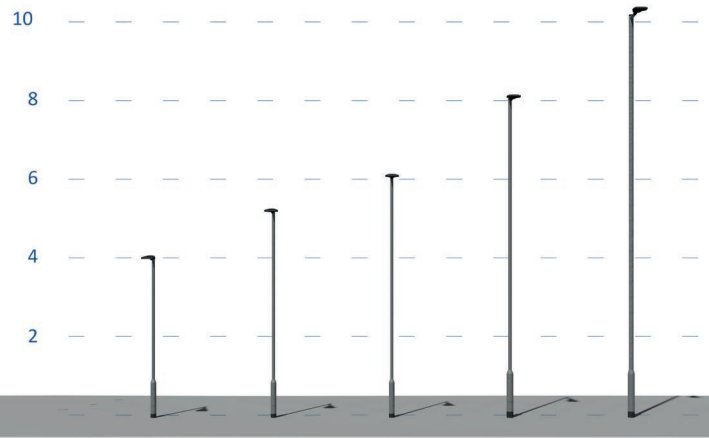

## Conical Steel (4m – 8m)

Suitable for residential and amenity areas, this option provides a sleek aesthetic and can be provided with a variety of paint options.

- Cone shaped – Circular, tapered from bottom to top
- Flush fitting door, laser cut from column body
- Flange plated or root mounted
- Available 4m-8m

## Octagonal Steel (4m – 15m)

Tapered from top to bottom, our robust selection of octagonal columns provide a strong solution to easily withstand the weight of flood lights and heavy duty bracketry.

- Expertly made using press bending & welding technique
- Available in mid-hinged option
- Available 4m-15m



# NATIONWIDE DELIVERY

Large Fleet

FORS Silver

EURO 6 Compliant

Free for orders over £500\*

Specialist lifting equipment

Delivery of up to 12m columns





**NHS**  
Highland  
Welcome to  
Broadford Hospital  
*Fàilte gu  
Ospadal an Àth Leathainn*

Entrance  
Drop Off Area  
Visitor Parking

Ambulance  
Services  
Only



No overnight parking



# Amenity and Highway Brackets

Our bracketry range is all manufactured in-house, in our fabrication facility based here at Kingfisher HQ. We offer carefully designed brackets for amenity and highway applications, as well as flood lighting and any other application you can think of.

Together, our Technical Design and Fabrication Teams will work with you to create bespoke bracketry to ensure your project meets exacting specifications and ensure a unique, quality result.

Created using high grade steel and hot dip galvanised, our range is built to last. With proven performance in most weather conditions, Kingfisher bracketry ensures confidence for years to come.

## Amenity Brackets

Designed to safely host amenity luminaires, this range offers a number of classic designs including the single and twin straight outreach bracket as well as a more classic crescent shaped design which, again can hold single or twin luminaires. The crescent bracket offers directional options to accommodate differing aesthetics or fitting types.



Single column adaptor 'AB 1'

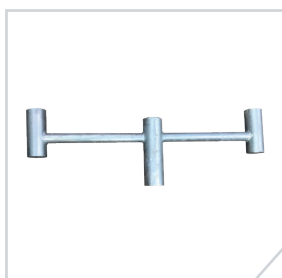

Precinct 'AB'



Crescent 'BB'

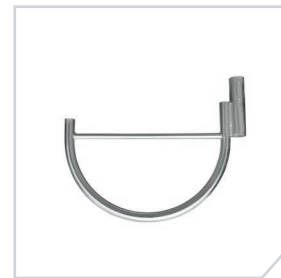

Crescent 'BBD'

## Highway Brackets

Manufactured to industry standards and galvanised BS EN ISO 1461. These simple yet strong options give the choice of single or twin 500mm outreach arms, which are perfect to support side entry luminaires.



Single Reach 'SR'



Double Reach 'DR'



# Flood Light Brackets

Secure and durable, we host a collection of robust brackets that are designed and built at Kingfisher HQ, to withstand the heavy load of flood lights.

All brackets are manufactured from high grade steel to ensure maximum strength as well as a hot dip galvanised finished as standard ensuring compliance with BS EN ISO 1461. We can also provide extra protection with a marine grade finish to alleviate concerns surrounding harsh environments.

We offer single, twin, triple and quad arm brackets and which can be painted in any RAL colours to suit site specifications. Our in-house fabrication and technical team create bespoke solutions for those extra difficult projects to create outstanding results.

With the customer in mind, we ensure all brackets are supplied with the relevant nuts, bolts and other fixings for maximised strength and stability on site.



Single flood light bracket 'STM1'



Twin flood light bracket 'STM2'



Triple flood light bracket 'STM3'



Quad arm flood light bracket 'STM4'



# Accessories

Light fixtures, brackets and columns are just part of the story. Our range of accessories will help take your scheme to the next level with options to protect schemes and save money. Designed to cover every aspect of your project, we offer a range of add-ons including fuse cut-outs, impact kits, column guards and more. Our expert team will be able to guide you through the options.

## Fuse Cut Outs

Fully complying to BS 7654, our Fuse Cut Outs allow for the safe termination of incoming and outgoing PVC and SWA cables. Manufactured from high spec thermoplastic, they're suitable for the fusing of single phase supply to your luminaires. Fuses range from 6A to 20A.



## Column Guards

Protection of columns can often be overlooked; however, we have a collection of column guards to prevent accidental impact and damage. This simple solution is the perfect accessory for busy car parks, retail spaces and industrial settings.

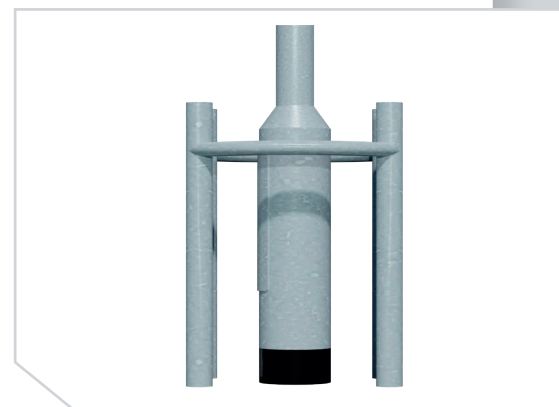

## Feeder Pillars

Providing a safe enclosure for remote control gear and the termination of supply cables, we have a wide collection of feeder pillars in a variety of sizes. We can even provide prewired feeder pillars to ensure easier on site installation.



## Impact Kit

Created to prevent the accidental damage of bollards, we have released an impact kit. Developed with a compression load of over 100kg, this kit will ensure greater security across your site and ensure your bollard stays protected.



## Spill Shields

Light obtrusion is becoming increasingly important throughout the industry and therefore, we have created spill solutions for some of our most popular products. From internal to external spill shields, we have you covered and can ensure obtrusive light is kept to a minimum across sites.





# Kingfisher CONTROLS

Part of the LUCECO group of companies

Our smart control system offers a wireless solution that has been designed to not only save you time on programming but to save energy output, and of course money.

Using this simple, yet powerful system will allow full control over your lighting scheme. We design a bespoke system to fit the needs of your site and its functions, making sure you get the most out of the lighting and take advantage of maximised savings.

## Switch Systems Explained

This system gives the user full control without all the bells and whistles of a more complex system.

This simple solution is perfect for schemes requiring a variety of outputs to service the differing functions on-site. With two options of set-up, this system is capable of being controlled from a simple push button scene switch or via a wireless device via a secure web portal.

### Simple Push Button System

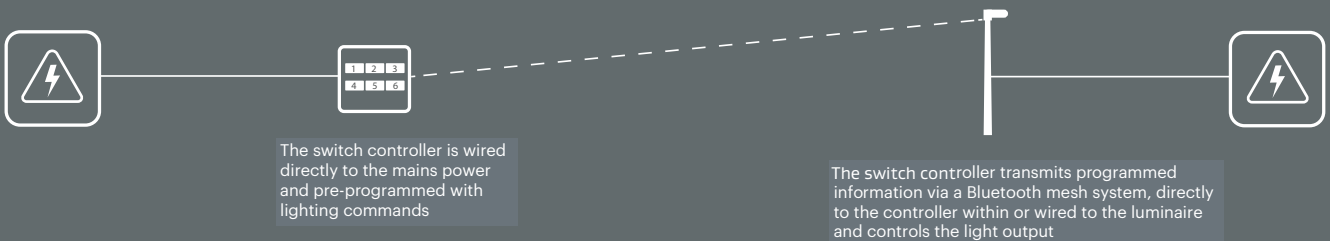

### Web-Based Interface

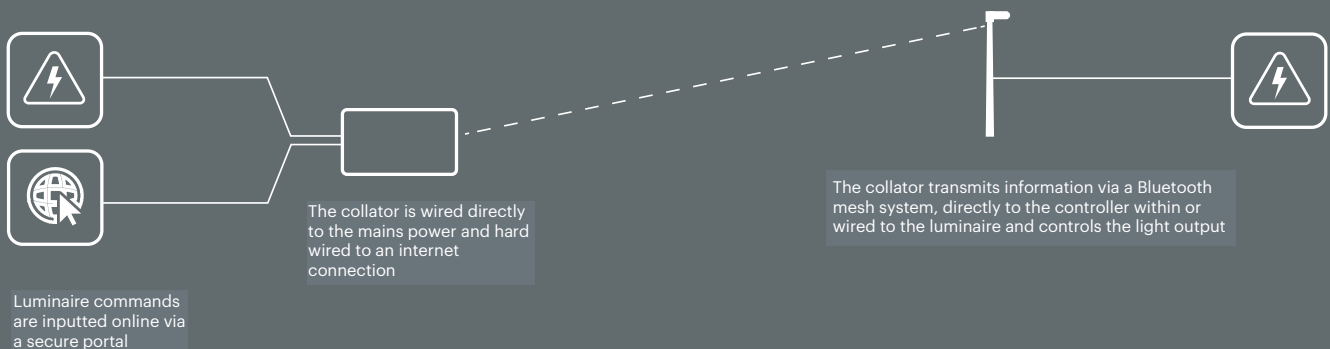

# Flexible Solutions

- Wireless or wired control capabilities
- Bespoke system design
- Simplified installation
- Easy scene setting
- DMX light shows
- Energy savings as standard
- User friendly interfaces
- Intelligent functionality
- Remote access
- Futureproof

## Controllers

The Kingfisher Control System starts with the controller, this forms the basis of all systems. These devices can be pre-fitted into each luminaire and give the ability to link, dim and control luminaires when integrated with dimmable drivers and sensors.

## Scene Switch

Scene setting is an important aspect of lighting control, but some systems are over complicated. Our scene switches are simple to use and install taking little or even no training to operate. The push-button panels and key fobs are pre-programmed before leaving KF HQ to your desired command and the system does the rest for you! Scene switches with 2, 4 or 6 buttons can be supplied for use with the 230V or battery powered controllers.

## Web Connected or Wired Solutions

Our controllers offer the perfect bespoke solution for wireless controls and scene setting. The controllers are installed into each luminaire and communicate directly to the scene switch. For locations without internet access, our wired system allows you to have the same functionality through access points. Collators allow for diagnostics and reporting on fittings as well as timed events via a web portal.

## Equipment

### Controller



### Scene Switch



### Collator



### Key Fob





# Kingfisher SPORT

Part of the LUCECO group of companies

Our dedicated sports division is led by a team of experts who specialise in lighting sports arenas. We service everything from grass roots pitches and community centres, all the way to professional facilities and stadiums.

Offering full end-to-end solutions, Kingfisher sport can provide everything from simply supply of units, to full project support, lighting design services, installation, commissioning and maintenance packages.

## Products

Our range of powerful sports fixtures include the mighty AMNIS Series. Design and engineered in the UK, AMNIS is designed using advanced reflector technology and offers a HDTV ready, flicker free illumination.

With an IDA fixed seal of approval and a flat to ground arrangement, with built in spill shield, this range of floods produce 0% ULOR and along with our lighting design team will produce schemes that create no obtrusive light, protecting local residents and wildlife, without compromising on performance.



## Lighting Design

Our dedicated team of designers have over 25 years' experience working with sports lighting and are fully qualified to produce superior scheme designs that meet or exceed all relevant standards such as Sport England regulation, as well as ILP GNo1 guidance.

The Team work closely with the customer and local planning authorities to ensure that all considerations and local environments are being assessed. Our meticulous process allows us to create perfect schemes every time.

## Controls

With Kingfisher Controls we can offer bespoke systems to perfectly service any requirements. From simple dimming to training areas focus, scene setting, all the way to complex DMX light shows.

Our control systems come with an easy to use interface and full training is offered to all users to ensure the system is fully up and running by the end of the project.

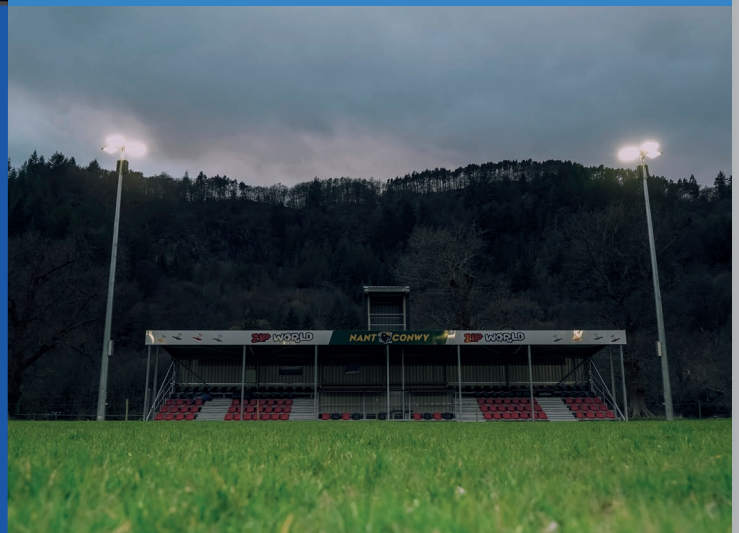





Montrose FC, Scotland



# Kingfisher HIGH MAST

Part of the LUCECO<sup>®</sup> group of companies

We supply, install and maintain all types of high mast lighting systems. We cover everything from road junctions, to docks and ports, airports and military zones.

Our 5-Step System shows the range of services we offer - you can take the full solution or only those parts you need.

## Products

We offer a range of powerful flood lights that have been specifically designed to give maximum areas lighting as well as focus task lighting. Our unique systems minimise light spillage to protect surrounding areas without compromising on performance.



## Up to 48m Masts

With a range of mast types, lowering systems and orientations, it can be a minefield to ensure you get the right mast for your site. Our dedicated Team will guide you through the options and help create a scheme that perfectly fits with your specification. We will work with local planning authorities to ensure all the boxes are ticked efficiently and standards are adhered to.

## Services

As well as providing luminaires and mast systems, we offer full installation, commissioning and maintenance packages to ensure your scheme is up and running within your desire timescale as well as keeping your system fully maintained for years to come.





Montrose Port, Scotland



# Kingfisher RAIL

Part of the LUCECO<sub>plc</sub> group of companies

The Kingfisher Rail and Infrastructure division specialise in just that. We offer a range of quality products and services for areas such as track sidings, stations, sub-stations plus surrounding facilities.

We offer an end-to-end solution including 3D/Virtual Reality visuals for large scale projects, lighting designs and even site audits where necessary. Our in-house experts are on hand to assist you from conception to completion.

## Products

VAILO is a unique GRP bollard with single or twin illumination and uses advanced technology to produce a powerful, yet controlled distribution. The bespoke optical system allows for superior spacings of up to 10m.

We also offer a range of post top, wall mounted and flood fittings that meet the strict standards surrounding the rail networks. Our expert team will guide you through all the intricacies from start to finish.



## Base Hinged Columns

Designed to exceed British Standards, these quality hot dip galvanised columns are made for strength and longevity. The base hinge design allows for quick and safe lowering using industry standard hydraulic raise and lower tools.

Our columns host a marine grade back board and earth braids as standard and are available for both flange mounting and rooted applications.

## Controls

Our smart control system offers a wireless solution that has been designed to not only save you time on programming but to save energy and of course money.

Using this simple, yet powerful system will allow full control over your lighting scheme. We design a bespoke system to suit the needs of your site and its functions, making sure you get the most out of the lighting and take advantage of maximum savings.





Thorpe Culvert, Lincolnshire

# Other Ranges



Luceco is one of the leading manufacturers of commercial lighting with over 10,000m<sup>2</sup> of UK Warehousing and distribution facility located in Telford, carrying approx. £20m stock.

Luceco carry a wide range of LED lighting products including commercial recessed options, high bay fixtures and emergency signage as well as domestic offerings such as flood light and household lamps.

## Twinspots

A range of emergency twinspots for high-level lighting. This product offers non-maintained operation with twin heads for maximum coverage. The heads are adjustable to ensure the coverage area can be adapted to suit the needs of the area. Offering 3 hours of maintained operation, and backed up by a 3-year warranty, safety is assured with the Luceco Twinspots.



## Tempus Bulkhead

A range of emergency bulkheads, the Tempus Bulkhead solutions offer a wealth of benefits. Constructed in polycarbonate with a clear diffuser, the Tempus Bulkheads offer additional protection through their IP65 rating. The bulkheads can be wall or ceiling mounted and provide 3 hours of maintained or non-maintained operation. With a cool white colour temperature of 6500k, the Tempus Bulkheads are suitable for a range of different projects.

## Ceres

Ceres is a comprehensive range of industrial luminaires manufactured with a diecast aluminium housing which offers increased thermal performance. Lumen options range from 110,000 to 35,500 in two, three or five rows of housing. With an IK10 rating and a lifespan of 100,000 hours, Ceres is built to last.





# Other Ranges



We have enjoyed an exclusive partnership with the Italian brand, AEC Illuminazione for 25 years and can offer a vast range of high-quality luminaires perfect for high spec projects and schemes. The AEC range boasts everything from powerful street fittings to spectacular architectural luminaires

## ITALO Series

This high-performance family of luminaires offers a wide optical range, all designed using advanced reflector technology, giving an efficient and visually comfortable distribution. Available in a range of body sizes and mounting options, ITALO is one of the best street lanterns on the market today.



## REVELAMPE Series

This versatile lantern series offers a wide range of options to accompany any heritage project. Pair with decorative columns and bracketry to further enhance the aesthetic of the project without compromising on quality or performance.

## MOD Series

The contemporary design of the MOD series sits perfectly with modern city aesthetics. With powerful flood and street options, bollards and tower with interchangeable modules such as CCTV, sensors and spot lights, this offering offers true versatility to create unique projects.





# Other Ranges

Exclusive partners for over 25 years, Arcluce are high-end architectural lighting specialists with a culture of high quality and creativity. All Arcluce products are created using the latest technologies and with cutting-edge components that guarantee reliability and long-lasting efficiency.



## PIXOL Series

This contemporary range offers everything from façade fittings to unique bollards and even flood options. With a range of powerful optics, the PIXOL family boasts versatility alongside efficiency and are available in a range of colours and finishes, including treated wood or die cast aluminium.

## Recessed Lighting

Arcluce boast a vast range of recessed luminaires such as drive over inground fittings, to brick lights to precision downlighters, all ranging from spots to large scale uplighters. The optical packages assist in the creation of specialist scheme design with long lasting results.



## LUNIO

LUNIO is an elegant LED amenity luminaire, which can be column, or wall mounted. It comes with a radial or 3-way distribution which makes it ideal for paths and parks as well as urban areas.

# Technical Symbols

Here's a quick guide to our technical symbols ensuring your product meets specification every time.



**IP55**  
Dust protected and 6.3mm water jet protected.

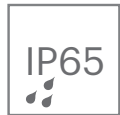

**IP65**  
Dust tight and 6.3mm water jet protected.



**IP66**  
Dust tight and 12.5mm heavy water jet protected.

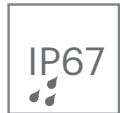

**IP67**  
Dust tight and water immersion beyond 1m.



**IK**  
Degrees of protection provided by enclosures for electrical equipment against external mechanical impacts as per EN62262.



**Controls Compatible**



**Class 1**  
These appliances must have their chassis connected to electrical earth.

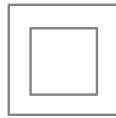

**Class 2**  
Double insulated, does not require a safety connection to electrical earth.



**Class 3**  
Supplied from a separated/safety extra low voltage power source.



**LED**  
Available with LED.



**Dimming**  
Suitable for dimming.



**RGB**  
Available with RGB colour changing.

## BREEAM

There are 3 credits available for external lighting

### Pol 04 Reduction of night time light pollution

Aim – To ensure that external lighting is concentrated in the appropriate areas and that upward lighting is minimised, reducing unnecessary light pollution, energy consumption and nuisance to neighbouring properties.

**Assessment criteria** – The external lighting strategy has been designed in compliance with Table 2 (and its accompanying notes) of the ILP Guidance notes for the reduction of obtrusive light, 2011.

### Hea 01 Visual comfort

Aim – To ensure daylighting, artificial lighting and occupant controls are considered at the design stage to ensure best practice in visual performance and comfort for building occupants.

**Assessment criteria** – External lighting. All external lighting located within the construction zone is designed to provide illuminance levels that enable users to perform outdoor visual tasks efficiently and accurately, especially during the night. To demonstrate this, external lighting provided is specified in accordance with BS 5489-1:2013 Lighting of roads and public amenity areas 3 and BS EN 12464-2:2014 Light and lighting - Lighting of work places - Part 2: Outdoor work places.

### Ene 03 External lighting

Aim – To recognise and encourage the specification of energy efficient light fittings for external areas of the development.

**Assessment criteria** – The average initial luminous efficacy of the external light fittings within the construction zone is not less than 60 luminaire lumens per circuit Watt.

\*Kingfisher Lighting Ltd offer a 5-year warranty on all LED luminaires (excluding Inground series) on the basis that they are installed and operated in accordance with the manufacturer's instructions and within all thermal, electrical and environmental limitations. Any modifications made to the product by the customer will invalidate the warranty. Kingfisher Lighting Ltd reserve the right to repair or replace products at their discretion. Replacement of products does not include costs associated with installation. Terms and conditions apply.

Note: All Kingfisher products are CE and UKCA Marked and Comply with UK and European health, safety and environmental legislation.  
Disclaimer: We reserve the right to make any changes to any product or information in this product guide at any time.  
All images are for illustrative purposes only and colours may vary. ©Kingfisher Lighting Ltd. 2023.



# Glossary

**Amp** - A measurement of the flow of electrical current. One amp is equal to the electric force of one volt acting across the resistance of one ohm.

**Ballast** - Device connected between the supply and one or more discharge lamps which serves mainly to limit the current of the lamps to the required value.

**Beam Angle** - Measures the spread of a light source. Lighting with a wider beam angle is more suitable for general purpose. Narrower beam angles are good for highlighting specific objects or areas.

**Colour rendering index (CRI)** - is a measure of the ability of a light source to reproduce the colours of various objects being lit by the source

**Colour Temperature** - A measure of how warm or cold a white light source appears. Warm light sources offer a softer, yellower light, while cool light sources emit a bluer, more intense light. Colour temperature is measured in Kelvins (K), and the lower the number, the warmer the light.

**Driver** - A driver is a device which controls the amount of power to an LED board or fitting, protecting it from sudden increases in voltage. Drivers are required to use low voltage LEDs and they can improve the performance and lifespan of LED light bulbs.

**Efficacy** - Is the amount of light produced per watt of electricity (comparable to efficiency). It is the rate at which a lamp is able to convert electrical power (watts) into light (lumens), expressed in terms of lumens per watt (LPW)

**Emergency Lighting** - Lighting that is designed to activate when a mains power outage occurs, usually powered by a rechargeable battery. Emergency lighting is useful when normal power may be cut off, and it is a health and safety requirement for areas around fire exits.

**Glare** - This occurs when the contrast between dark and light is accentuated. This can cause discomfort for people using spaces near the luminaire.

**Heat Sink** - A heat sink is used to draw heat away from certain parts of an electronic circuit. Because LEDs are sensitive to heat, a heat sink is often an important part of a luminaire. Heat sinks help to preserve the lifespan of LED lights.

**IP Rating** - An IP rating is a way of showing how effective an item is at blocking out foreign bodies. The IP stands for Ingress Protection and the following numbers (i.e. IP67, IP56, etc) refer to the protection an item offers against the intrusion of the two categories of foreign bodies, i.e. solid (e.g. dust) and liquid (water).

**IK Rating** - The IK rating is an international standard that indicates how resistant a product is to impact. The standard BS EN 62262 relates to IK ratings, to identify the degree of protection provided by enclosures for electrical equipment against external mechanical impacts.

**Lumen** - The quantity of luminous flux emitted within a unit solid angle (one steradian) by a point source with one candela intensity in all directions.

**Lux** - The amount of visible light per square meter incident on a surface. 1 lux = 1 lumen/square meter

**Maintenance Factor** - A lighting system's maintenance factor indicates how much of the initial luminous flux remains available at the end of its service life. The maintenance factor must be determined by the lighting designer and the new value of the luminous flux multiplied by it.

**Obtrusive Light** - This is any unwanted light that is illuminating areas near a light source. For example, a luminaire that shines light onto a nearby residential areas or wildlife habitat.

**PIR** - Stands for Passive Infrared detection device. In lighting, it is connected to a luminaire. A PIR detection device turns the light on or off when there is a large change in infrared activity, usually when someone enters or exits a room. This helps to save energy. PIRs are frequently used in security lighting.

**Photocell** - These are sensors that change resistance depending on the amount of light it detects. Simply put, a photocell will allow the light source to activate when little to no light is detected, meaning the luminaires are activated when natural light deteriorates.

**Power Factor** - This is the ratio of power actually used in an electric circuit, the real power (expressed in kW), to the power that is apparently being drawn from the power source, the apparent power (expressed in kVA).

**Reflector Technology** - This solution is precisely designed to concentrate the light from the LED chips and project a focused beam pattern to put the light where you need it using a series of 'reflectors'. This technology is used to reduce glare, obtrusive light and promote comfort.

**Uniformity** - This is the ratio of the minimum lighting level to the average lighting level in a specified area. It's a quality parameter for the overall illuminance distribution.

**Upward Light Output Ratio (ULOR)** - The effectiveness of a luminaire in transmitting the light from the lamp out into the environment

**Volt** - The unit of electrical potential, or difference in electrical pressure, expressing the difference between two electrical charges.

**Watt** - A standard unit of power defined as one Joule of energy transferred or dissipated in one second.

**Wind Area / Windage** - A general term describing the amount of exposure of an object to the force of the wind.



# Project Lighting Design

Lighting regulations are getting increasingly stricter in accordance with lighting guidance and therefore this can make it trickier to meet set specifications. However, through utilising a skilled lighting design team, you will not only meet specifications but save money, improve performance and efficiency.

Dedicated to enhancing our customers sites, we have a skilled in-house lighting design team who are knowledgeable regarding lighting legislation regulation and all relevant ILP guidance. A hot topic in the industry is environmental considerations especially catering for dark sky areas and areas of great ecological concern.

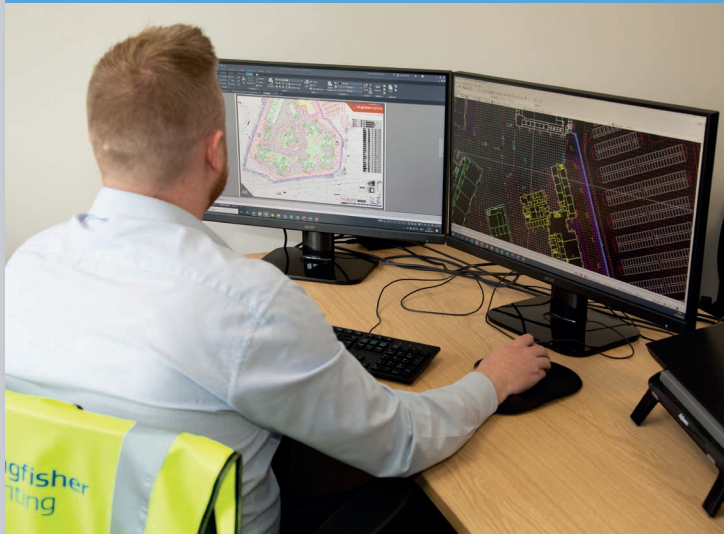
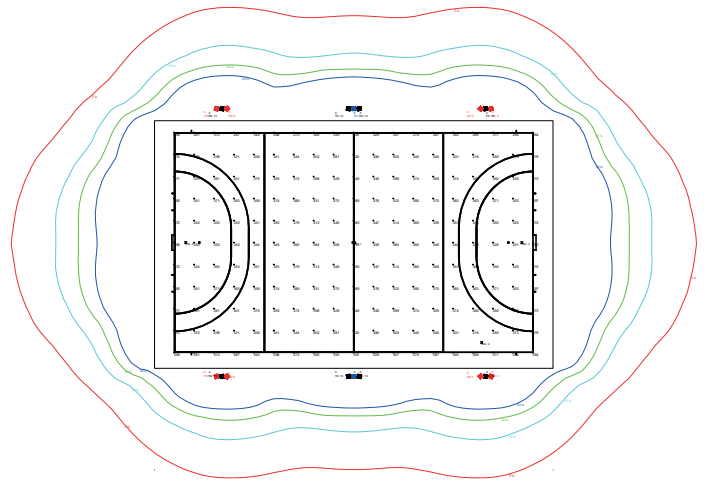

The Kingfisher Lighting Design team have the latest knowledge and utilise our comprehensive product range in order to produce a state-of-the-art lighting design. We also have a dedicated dark skies range which have the 'IDA's Seal of Approval' ensuring we're a recommended manufacturer within these areas.

We also have experience illuminating prisons, ports, public realm, sports sites and architectural areas so be sure to check out some of our case studies on our website!

For further information on our lighting design services please contact our team at [sales@kingfisherlighting.com](mailto:sales@kingfisherlighting.com)



# Key Contacts

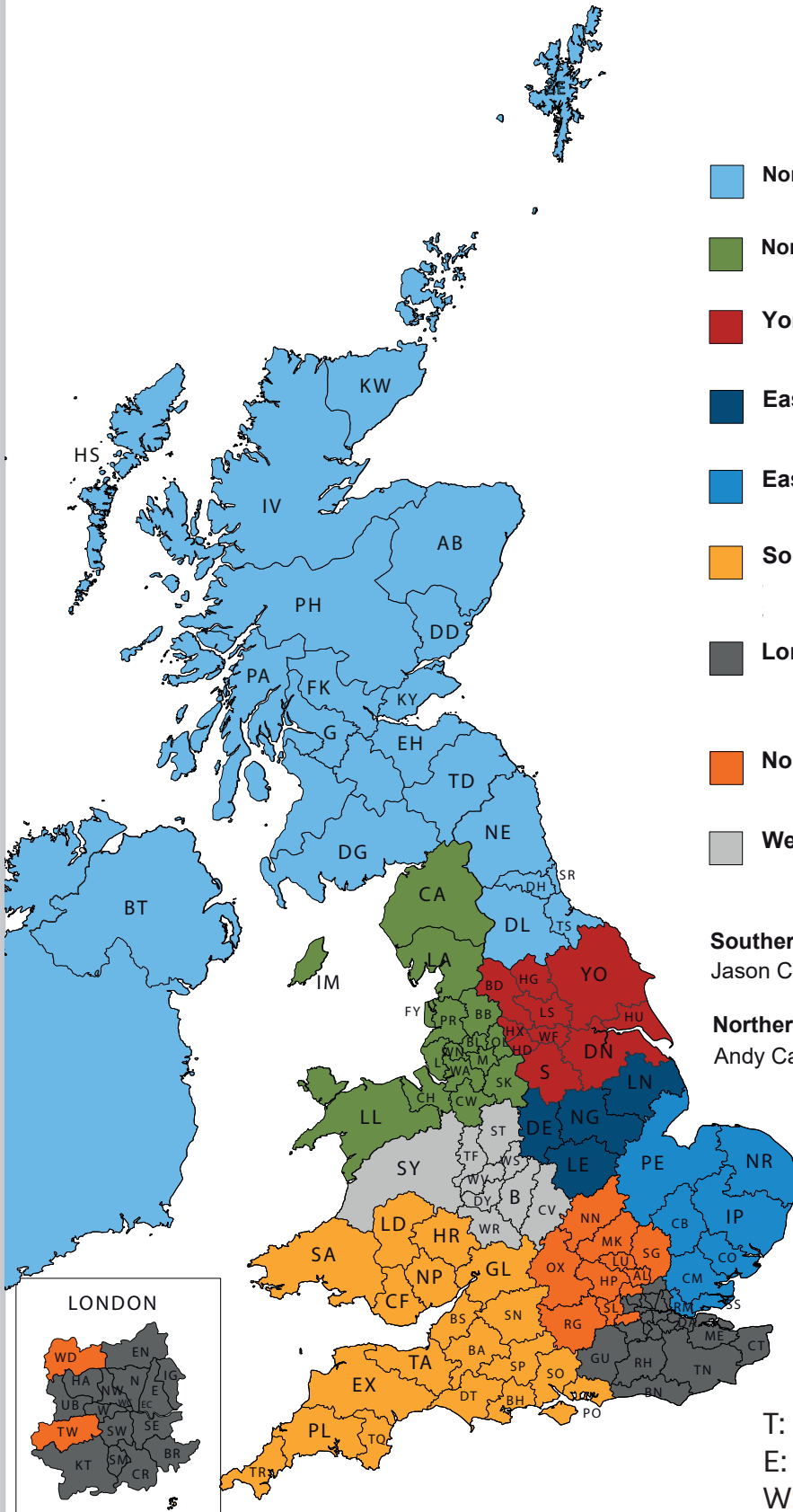

- North East, Scotland & N. Ireland**  
01623 415946
- North West**  
01623 415946
- Yorkshire**  
01623 392276
- East Midlands & Lincolnshire**  
01623415925
- East Anglia**  
01623 415947
- South West**  
01623 415916  
01623 415933
- London & South East**  
01623 392272  
01623 415210
- Northern Home Counties**  
01623 415902
- West Midlands**  
01623 392278

**Southern Distribution Sales Representative**  
Jason Canavan 07974 454604

**Northern Distribution Sales Representative**  
Andy Campion 07917 398216

T: +44 (0)1623 415900  
E: [sales@kingfisherlighting.com](mailto:sales@kingfisherlighting.com)  
W: [kingfisherlighting.com](http://kingfisherlighting.com)

# Product Index

<b>A</b>	About Us .....	<b>4</b>	<b>K</b>	Key Contacts .....	<b>69</b>
	Accessories .....	<b>53</b>		Kingfisher Controls .....	<b>54</b>
	ALFRESCO Urban .....	<b>32</b>		Kingfisher High Mast .....	<b>58</b>
	Amenity and Highway Brackets .....	<b>50</b>		Kingfisher Rail .....	<b>60</b>
	Amenity Lighting .....	<b>16</b>		Kingfisher Sport .....	<b>56</b>
	AMNIS Series .....	<b>41</b>	<b>L</b>	Lighting Design Service .....	<b>68</b>
	Ask Technical .....	<b>7</b>		LUCECO .....	<b>62</b>
	ATLAS .....	<b>34</b>		Luminaire Accessories .....	<b>42</b>
	AURIGA 2.0 (Post Top) .....	<b>12</b>	<b>M</b>	Motion Sensor .....	<b>42</b>
	AURIGA 2.0 (Stirrup) .....	<b>20</b>	<b>O</b>	Other Products Available .....	<b>64</b>
<b>B</b>	Bollards .....	<b>22</b>	<b>P</b>	Paint Options .....	<b>43</b>
	Bulkheads .....	<b>28</b>		Photocell .....	
<b>C</b>	CIRECO .....	<b>15</b>		PIR .....	<b>42</b>
	CIVICA 2.0 .....	<b>21</b>	<b>Q</b>	QUARTO 2.0 .....	<b>33</b>
	Columns Guards .....	<b>52</b>	<b>S</b>	SEMITA Arc .....	<b>30</b>
	Columns .....	<b>46</b>		SEMITA Urban .....	<b>31</b>
<b>D</b>	DECO 2.0 .....	<b>27</b>		Single Spectrum .....	<b>43</b>
	DIM to Warm .....	<b>43</b>		SLOANE 2.0 .....	<b>19</b>
<b>E</b>	Emergency .....	<b>42</b>		Spill Shields .....	<b>53</b>
	Environmental .....	<b>8</b>		Street Lighting .....	<b>10</b>
<b>F</b>	Feeder Pillars .....	<b>52</b>	<b>T</b>	Technical Symbols .....	<b>66</b>
	Flood Light Brackets .....	<b>51</b>	<b>V</b>	VAILO .....	<b>25</b>
	Flood Lighting .....	<b>36</b>		VILLA II .....	<b>18</b>
	FORTIS .....	<b>35</b>		VIVA-CITY Flood .....	<b>39</b>
	Fuse Cut Outs .....	<b>52</b>		VIVA-CITY Pro .....	<b>13</b>
<b>G</b>	GUARDIAN Pro .....	<b>38</b>	<b>Z</b>	ZACTIS .....	<b>40</b>
<b>H</b>	HELVELLYN 2.0 .....	<b>26</b>			
<b>I</b>	Impact Kits .....	<b>53</b>			
	I-TRON .....	<b>14</b>			

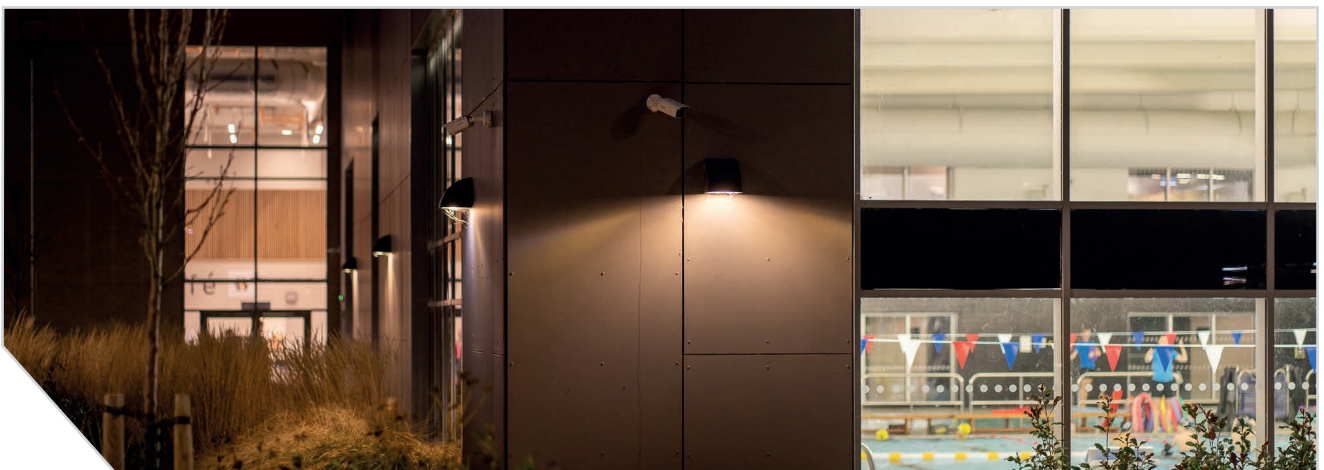

# Kingfisher Lighting Guides

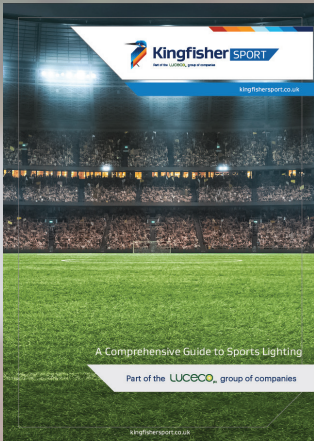

## Kingfisher Sport

From grass roots pitches to stadiums and arenas, let us guide you through the world of sports lighting.

This guide is packed full of information about standards, guidance notes, product information and maintenance guides.



## Technical Handbook

This pocket-sized guide is an invaluable tool for contractors with detailed information on standards, guidance notes, spacings, optical performance, as well as maintenance info plus more!!



## Kingfisher High Mast

We have developed a simple 5-step system to help guide our customers through the intricacies of high mast lighting. Get in touch and the team will walk you through the best solutions for your site.



## Specification Guide

Packed full of high-end architectural products and solutions for technical and architectural projects.

This guide is useful information on our optical packages, RGB offerings as well as our environmental work.



## Kingfisher Rail

Our dedicated Rail division was set up to guide our customers through the detailed supported needed within this sector. Our specially designed products are perfect the options for rail sidings, trackside and platform lighting.

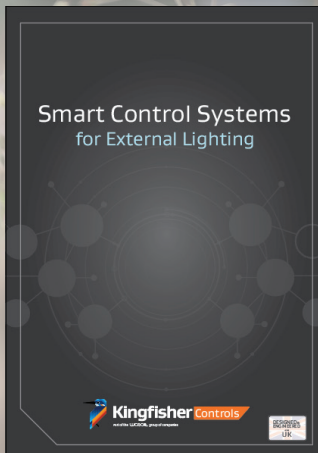

## Kingfisher Controls

With a dedicated smart controls range, this will guide you through how to maximise your lighting scheme using our range of control packages. Our experts will create a perfectly efficient scheme that can develop as your site does.





# Kingfisher Lighting

Part of the LUCGCO, group of companies

Ratcher Way  
Crown Farm Business Park  
Mansfield  
Nottinghamshire  
NG19 0FS  
UK  
T: +44 (0)1623 415900  
E: [sales@kingfisherlighting.com](mailto:sales@kingfisherlighting.com)  
[kingfisherlighting.com](http://kingfisherlighting.com)